

TSB SERIES W/ 6" DROP FRONT

SPECIFICATIONS

PRE-CAST TERRAZZO OF BLACK & WHITE MARBLE CHIPS IN GRAY CEMENT AND A 3" STAINLESS STEEL DRAIN BODY CAST INTEGRAL WITH A REMOVABLE STRAINER PLATE MADE OF STAINLESS STEEL

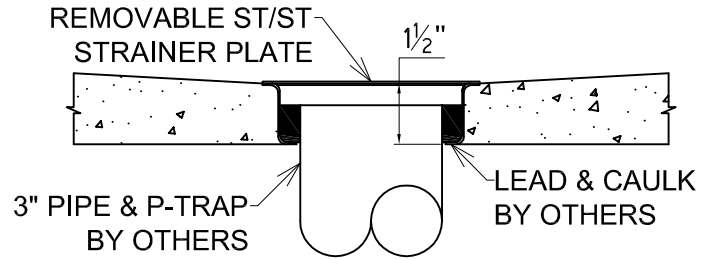
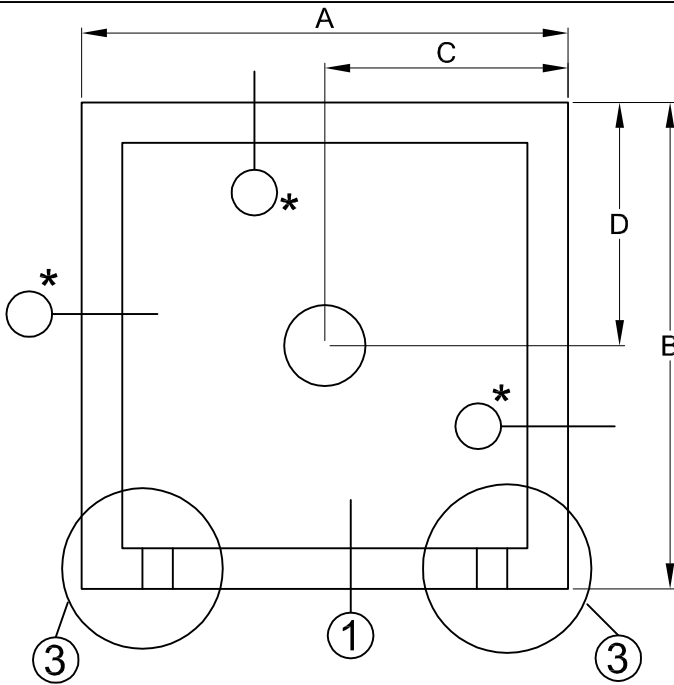

SECTION THRU DRAIN

* SELECT SECTION AS TO APPROPRIATE SIDE (PLAIN, FLANGED OR CAPPED)

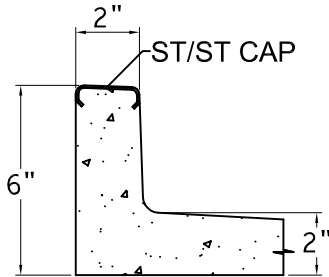

SECTION 1
THRESHOLD W/ ST/ST CAP

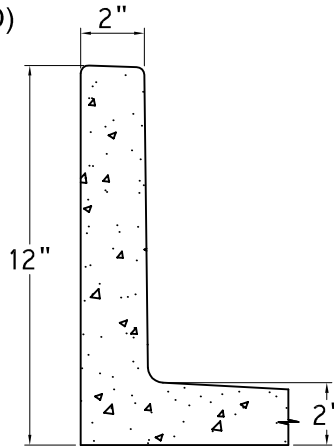

SECTION 2
SHOULDER

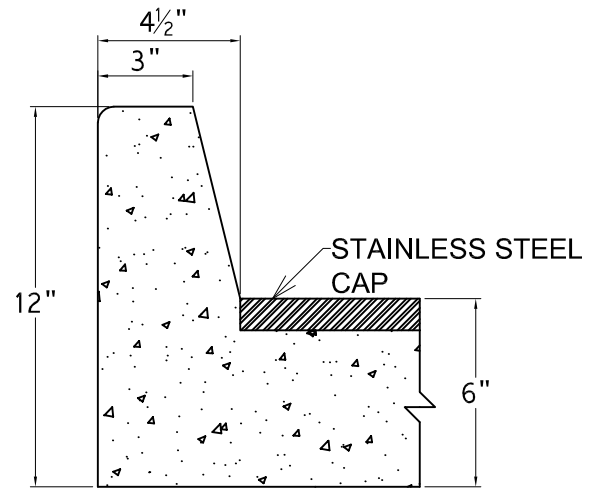

SECTION 3
DROP FRONT

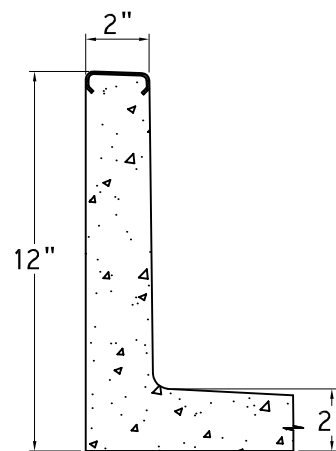

SECTION 4
SHOULDER W/ ST/ST CAP

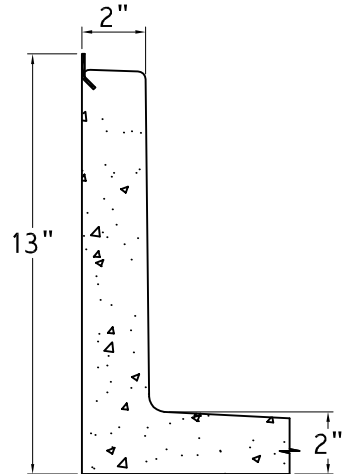

SECTION 5
SHOULDER W/ FLANGE

NOTE: ESTABLISH $\frac{1}{4}$ " INCH CLEARANCE BETWEEN SHOWER FLOOR AND WALL. IT IS IMPORTANT THAT ENTIRE AREA BETWEEN RECEPTOR AND BUILDING FLOOR HAVE A LAYER OF MORTAR IN ORDER THAT SHOWER FLOORS BE LEVEL.

QTY	SIZE	A	B	C*	D*

* INDICATES DRAIN LOCATION. DIMENSIONS MUST BE SPECIFIC, ESPECIALLY WITH OFFSET DRAIN.

DRAIN SIZE (OTHER THAN 3"): _____

COLOR (OTHER THAN BLACK & WHITE) _____

ADDITIONAL CAPS IN ADDITION TO THRESHOLD _____

IMPORTANT: DUE TO THE NATURE OF MATERIAL AND MANUFACTURING PROCESS THE ACTUAL DIMENSIONS MAY VARY $\pm \frac{1}{4}$ "

NOTE: CUSTOMER TO REVIEW, VERIFY, AND APPROVE DRAWING FOR PRODUCTION. ONCE DRAWING IS SIGNED FOR APPROVAL AND SUBMITTED WITH ORDER, THE ORDER SHALL BE **NON-CANCELABLE**.

DWG. APPROVED:	DATE:
CUST: _____	
JOB: _____	
ORDER #:	



CUSTOMER SERVICE
UNITED STATES
1-800-442-1902
www.fiatproducts.com

CUSTOMER SERVICE
CANADA
1-800-387-0369
www.fiat.ca